



EUROFINS PRODUCT TESTING SERVICE (SHANGHAI) CO., LTD.

EMC TEST- REPORT

TEST REPORT NUMBER: EFSH20050919-IE-01-E01



Eurofins Product Testing Service (Shanghai) Co., Ltd.
No.395 West Jiangchang Road, Jing'an District, Shanghai,
200436, P.R. China

Phone: +86-21-61819181
Fax: +86-21-61819180
Page 1 of 35

TABLE OF CONTENTS

1 Contents

1	Contents	2
2	General Information	3
2.1	Notes	3
2.2	Testing laboratory	4
2.3	Details of approval holder	5
2.4	Application details	5
2.5	EUT information	5
2.6	Test standards	5
3	Technical test	6
3.1	Summary of test results	6
3.2	Test environment	6
3.3	Test mode	6
3.4	List of Test equipment	7
3.5	Test results	8
4	Emission Test	9
4.1	Conducted Emission	9
4.2	Radiated electromagnetic disturbances	12
4.3	Radiated disturbance	16
4.4	Voltage Changes, Voltage Fluctuations and Flicker	19
5	Immunity Test	20
5.1	Performance Criteria Description in Clause 4 of EN 61547	20
5.2	Conditions during testing	20
5.3	Electrostatic discharge	21
5.4	Radio frequency electromagnetic fields	22
5.5	Electrical Fast Transients	23
5.6	Surge Immunity	24
5.7	Injected currents (RF continues conducted)	25
5.8	Power-frequency magnetic fields	26
5.9	Voltage dips and Interruption	27
6	Test setup Photos	28
7	EUT Photos	33

2 General Information

2.1 Notes

The results of this test report relate exclusively to the item tested as specified in chapter “Description of test item” and are not transferable to any other test items.

Eurofins Product Testing Service (Shanghai) Co., Ltd. is not responsible for any generalisations and conclusions drawn from this report. Any modification of the test item can lead to invalidity of test results and this test report may therefore be not applicable to the modified test item.

The test report may only be reproduced or published in full. Reproducing or publishing extracts of the report requires the prior written approval of the Eurofins Product Testing Service (Shanghai) Co., Ltd.

This document is subject to the General Terms and Conditions and the Testing and Certification System of Eurofins Product Testing Service (Shanghai) Co., Ltd., available on request or accessible at <https://www.eurofins.cn/en/eurofins-consumer-product-testing-china/resource-centre/general-terms/>.

Operator:

2020-05-27		Perry Li / Project Engineer	
------------	--	-----------------------------	---------------------------------------------------------------------------------------

Date	Eurofins-Lab.	Name / Title	Signature
------	---------------	--------------	-----------

Technical responsibility for area of testing:

2020-05-27		Andy Li / Supervisor	
------------	--	----------------------	--------------------------------------------------------------------------------------

Date	Eurofins	Name / Title	Signature
------	----------	--------------	-----------

2.2 Testing laboratory

Eurofins Product Testing Service (Shanghai) Co., Ltd.

No.395 West Jiangchang Road, Jing'an District, Shanghai, 200436, P.R. China

Telephone : +86-21-61819181

Telefax : +86-21-61819180

Test location, where different:

Subcontractor

Name : Eurofins Electrical Testing Service (Shenzhen) Co., Ltd.
Address : 1st Floor, Building 2, Chungu, Meisheng Huigu Science and
Technology Park, No. 83 Dabao Road, Bao'an District, Shenzhen,
P. R. China
Telephone : +86-755-82911867
Fax : +86-755-82910749

Radiated emission and radiated immunity tests were performed at Eurofins Electrical Testing Service (Shenzhen) Co., Ltd.

2.3 Details of approval holder

Name : ES Escalator Parts Co., Ltd.
Address : Rm 104, 6# Building, Zijin Jiayue Apt, No.7 Xingfu Rd, Xuanwu Dist.,
Nanjing, 210046, China
Telephone : ./.
Fax : ./.

2.4 Application details

Date of receipt of test item : 2020-05-14
Date of test : 2020-05-14 to 2020-05-24

2.5 EUT information

Product type : Sterile Touch - Sapphire LED UV-C Handrail Sterilization Module
Model name : ES20200101
Brand name : ./.
Serial number : ./.
Ratings : 24VDC, Class I, 6.24W
Test voltage : 230V~, 50Hz (For power supply)
Additional information : The luminaire is LED UV-C handrail sterilization module with external
power supply
Power supply: M/N: S-25-24
Input: 200-240VAC, 50/60Hz
Output: DC 24V,1A

2.6 Test standards

Technical standard :

EN IEC 55015: 2019

EN 61547:2009

EN 61000-3-2:2014

EN 61000-3-3:2013

3 Technical test

3.1 Summary of test results

No deviations from the technical specification(s) were ascertained in the course of the tests performed.



or

The deviations as specified were ascertained in the course of the tests performed.



3.2 Test environment

Eurofins Product Testing Service (Shanghai) Co., Ltd.

Temperature	:	20	...	25°C
Relative humidity content	:	30	...	60%
Air pressure	:	100	...	103kPa

Eurofins Electrical Testing Service (Shenzhen) Co., Ltd.

Temperature	:	25.6°C
Relative humidity content	:	57.9%
Air pressure	:	101.5kPa

3.3 Test mode

Lighting

3.4 List of Test equipment

Measurement Equipment List				
No.	Name	Model	Manufacturer	Cal. due date
1	EMI test receiver	ESCI	R&S	2020-11-21
2	Triple Loop Antenna	HXYZ 9170	Schwarzbeck	2020-11-21
3	Single phase Harmonics & Flicker analyser	PACS-1	California Instruments	2020-11-21
4	AC Power Source	5001ix	California Instruments	2020-11-21
5	Coupling/Decoupling Network	L 801 M2/M3	Luethi	2020-11-21
6	Ultra Compact Simulator	UCS 500N7	EMTEST	2020-11-21
7	ESD Gun	NSG 437	TESEQ	2020-07-10
8	Current transformer	MC2630	EMTEST	2020-11-21
9	Motorized variac	MV2616	EMTEST	2020-11-21
10	Continuous wave simulator	CWS500N1	EMTEST	2020-11-21
11	Magnetic field coil	MS100	EMTEST	2020-11-21
12	Current transformer	MC26100	EMTEST	2020-11-21
13	Artificial mains	ENV216	R&S	2020-11-21
14	EMI Test Receiver	ESR7	R&S	2021-04-03
15	TRILOG Broadband Antenna	VULB9168	Schwarzbeck	2021-04-12
16	Preamplifier	BBV9745	Schwarzbeck	2021-04-14
17	Preamplifier	TAP18040048	Tonscend	2021-04-13
18	Horn Antenna	3117	ETS-Lindgren	2021-04-12
19	Log.-Per.-Broadband Antenna	STLP9129	Schwarzbeck	2021-05-03
20	Signal Generator	N5171B-506	Keysight	2021-04-13
21	Power meter	N1914A	Keysight	2021-05-04
22	Average power sensor	E9301A	Keysight	2021-04-13
23	Average power sensor	E9301A	Keysight	2021-04-13
24	Broadband Amplifier	CBA6G-050D	TESEQ	2021-05-04
25	Broadband Amplifier	CBA1G-150B	TESEQ	2020-07-05

3.5 Test results

 1st test

 test after modification

 production test

Test case	Subclause	Required	Test passed	Test failed
Conducted Emission	Clause 4.3 of EN IEC 55015	<input checked="" type="checkbox"/>	<input checked="" type="checkbox"/>	<input type="checkbox"/>
Radiated electromagnetic disturbances	Clause 4.5.2 of EN IEC 55015	<input checked="" type="checkbox"/>	<input checked="" type="checkbox"/>	<input type="checkbox"/>
Radiated disturbance	Clause 4.5.3 of EN IEC 55015	<input checked="" type="checkbox"/>	<input checked="" type="checkbox"/>	<input type="checkbox"/>
Harmonic Current Emissions	EN 61000-3-2	<input checked="" type="checkbox"/>	<input checked="" type="checkbox"/>	<input type="checkbox"/>
Voltage Changes, Voltage Fluctuations and Flicker	EN 61000-3-3	<input checked="" type="checkbox"/>	<input checked="" type="checkbox"/>	<input type="checkbox"/>
Electrostatic Discharge	Clause 5.2 of EN 61547 & IEC 61000-4-2	<input checked="" type="checkbox"/>	<input checked="" type="checkbox"/>	<input type="checkbox"/>
Radio frequency electromagnetic fields	Clause 5.3 of EN 61547 & IEC 61000-4-3	<input checked="" type="checkbox"/>	<input checked="" type="checkbox"/>	<input type="checkbox"/>
Power frequency magnetic fields	Clause 5.4 of EN 61547 & IEC 61000-4-8	<input checked="" type="checkbox"/>	<input checked="" type="checkbox"/>	<input type="checkbox"/>
Electrical Fast Transients	Clause 5.5 of EN 61547 & IEC 61000-4-4	<input checked="" type="checkbox"/>	<input checked="" type="checkbox"/>	<input type="checkbox"/>
Injected currents (RF common mode)	Clause 5.6 of EN 61547 & IEC 61000-4-6	<input checked="" type="checkbox"/>	<input checked="" type="checkbox"/>	<input type="checkbox"/>
Surge immunity	Clause 5.7 of EN 61547 & IEC 61000-4-5	<input checked="" type="checkbox"/>	<input checked="" type="checkbox"/>	<input type="checkbox"/>
Voltage dips and short interruption	Clause 5.8 of EN 61547 & IEC 61000-4-11	<input checked="" type="checkbox"/>	<input checked="" type="checkbox"/>	<input type="checkbox"/>

4 Emission Test

4.1 Conducted Emission

This clause lays down the general requirements for the measurement of disturbance voltage produced at the terminals of apparatus.

4.1.1 Limits

Frequency range MHz	At mains terminals dB (μ V)	
	Quasi-peak	Average
0.009 to 0.05	110	--
0.05 to 0.15	90 to 80	--
0.15 to 0.50	66 to 56	56 to 46
0.50 to 5	56	46
5 to 30	60	50

Note1: The limit decreases linearly with the logarithm of the frequency in the range 50k to 150kHz and 150 kHz to 0.5 MHz.

Note2: The lower limit is applicable at the transition frequency.

4.1.2 Measurement procedure

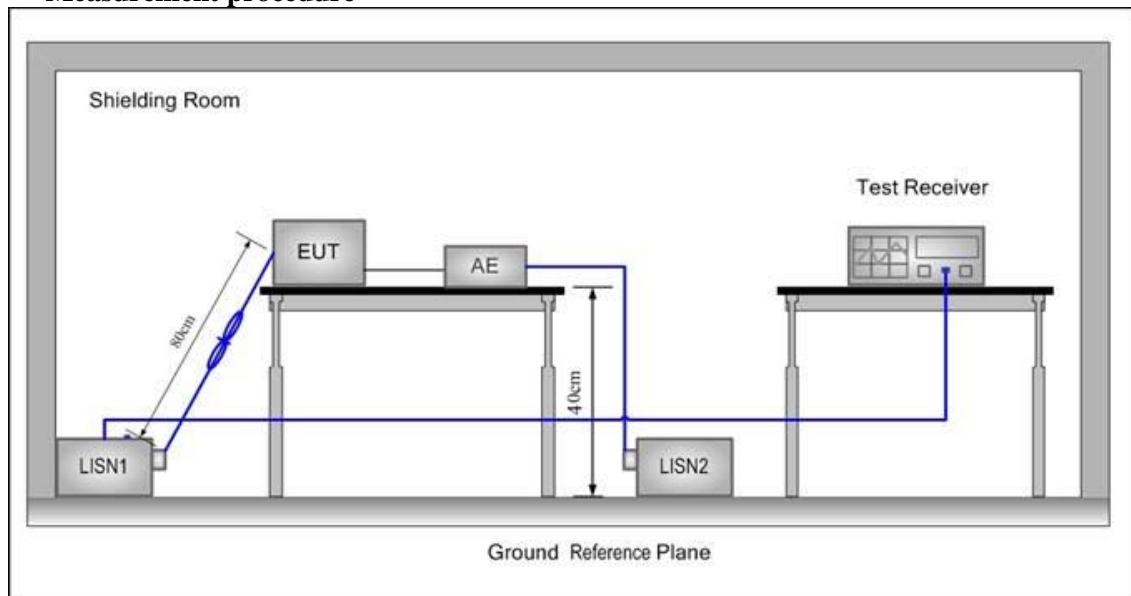

1. The mains terminal disturbance voltage was measured with the EUT in a shielded room.
2. The EUT was connected to AC power source through a LISN (Line Impedance Stabilization Network) which provides a $(50 \mu\text{H} + 5 \Omega) \parallel 50 \Omega$ linear impedance. The power cables of all other units of the EUT were connected to a second LISN, which was bonded to the ground reference plane in the same way as the LISN for the unit being measured.
3. The tabletop EUT was placed upon a non-metallic table 0.4m above the ground reference plane. And for floor-standing arrangement, the EUT was placed on the horizontal ground reference plane, but separated from metallic contact with the ground reference plane by 0.1m of insulation.

4. Before get the final emission results with quasi-peak(QP) detector and average(AV) detector, a pre-scan was performed with the peak(PK) and average(AV) detector to find out the maximum emission data plots of the EUT.

4.1.3 Measurement uncertainty

U_{lab}(cond) = 2.5dB at 95% level of confidence, k=2

4.1.4 Results -Measurement Data

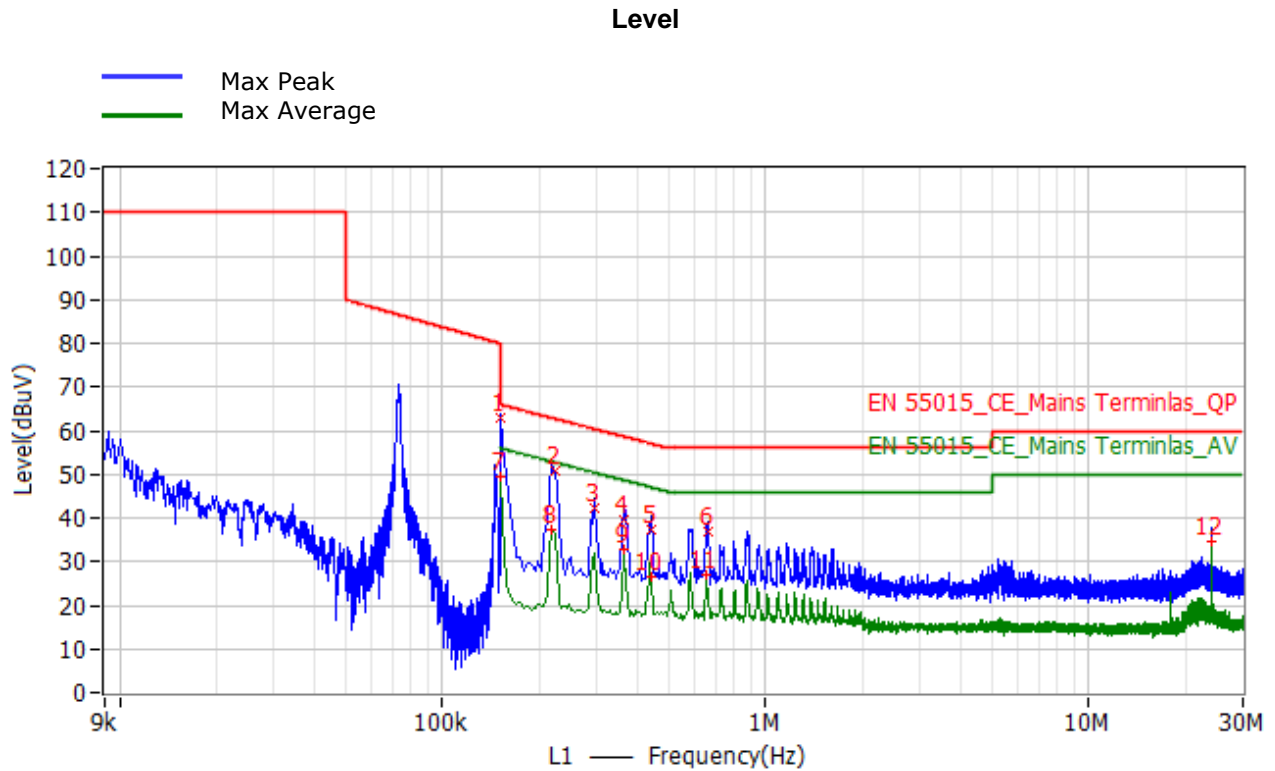

No.	Frequency	Limit dBuV	Level dBuV	Delta dB	Factor dB	Detector	Phase
1	150.000 kHz	66.0	62.7	-3.3	10.4	QP	L1
2	222.000 kHz	62.7	50.6	-12.2	10.4	QP	L1
3	294.000 kHz	60.4	42.2	-18.2	10.4	QP	L1
4	362.000 kHz	58.7	39.7	-19.0	10.4	QP	L1
5	442.000 kHz	57.0	37.5	-19.5	10.4	QP	L1
6	666.000 kHz	56.0	36.9	-19.1	10.5	QP	L1
7	150.000 kHz	56.0	49.6	-6.4	10.4	CAV	L1
8	218.000 kHz	52.9	37.3	-15.6	10.4	CAV	L1
9	366.000 kHz	48.6	32.6	-16.0	10.4	CAV	L1
10	442.000 kHz	47.0	26.7	-20.3	10.4	CAV	L1
11	654.000 kHz	46.0	27.0	-19.0	10.5	CAV	L1
12	23.910 MHz	50.0	34.8	-15.2	10.6	CAV	L1

Level

— Max Peak
— Max Average

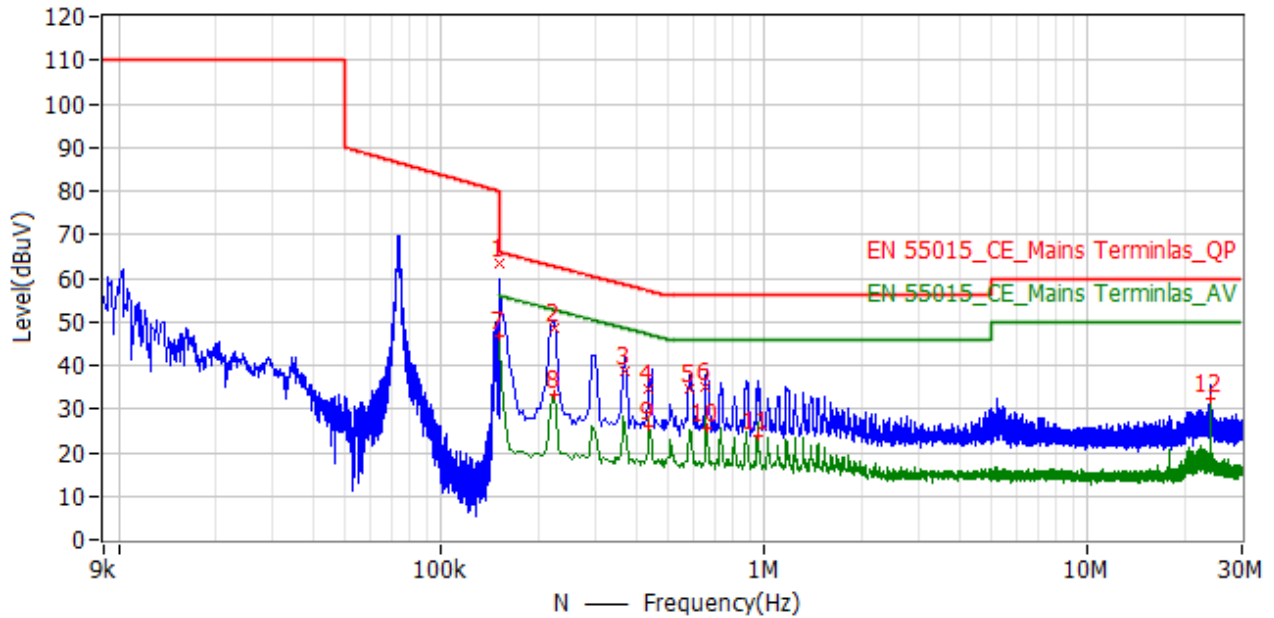

No.	Frequency	Limit dBuV	Level dBuV	Delta dB	Factor dB	Detector	Phase
1	150.000 kHz	66.0	63.3	-2.7	10.2	QP	N
2	222.000 kHz	62.7	48.6	-14.1	10.3	QP	N
3	370.000 kHz	58.5	38.6	-19.9	10.4	QP	N
4	438.000 kHz	57.1	34.6	-22.5	10.4	QP	N
5	586.000 kHz	56.0	34.7	-21.3	10.4	QP	N
6	658.000 kHz	56.0	35.1	-20.9	10.4	QP	N
7	150.000 kHz	56.0	46.8	-9.2	10.2	CAV	N
8	222.000 kHz	52.7	33.1	-19.7	10.3	CAV	N
9	438.000 kHz	47.1	26.2	-20.9	10.4	CAV	N
10	662.000 kHz	46.0	25.6	-20.4	10.4	CAV	N
11	954.000 kHz	46.0	23.8	-22.2	10.4	CAV	N
12	23.930 MHz	50.0	32.2	-17.8	10.6	CAV	N

4.2 Radiated electromagnetic disturbances

This clause lays down the general requirements for the magnetic component of the radiated disturbance field strength in the frequency range 9 kHz to 30 MHz

4.2.1 limits

Frequency range Hz	Limits for loop diameter dB (μ A)
9 kHz to 70 kHz	88
70 kHz to 150 kHz	88 to 58
150 kHz to 3 MHz	58 to 22
3 MHz to 30 MHz	22

Note: At the transition frequency, the lower limit applies.
Decreasing linearly with the logarithm of the frequency.
Increasing linearly with the logarithm of the frequency.

4.2.2 Measurement procedure

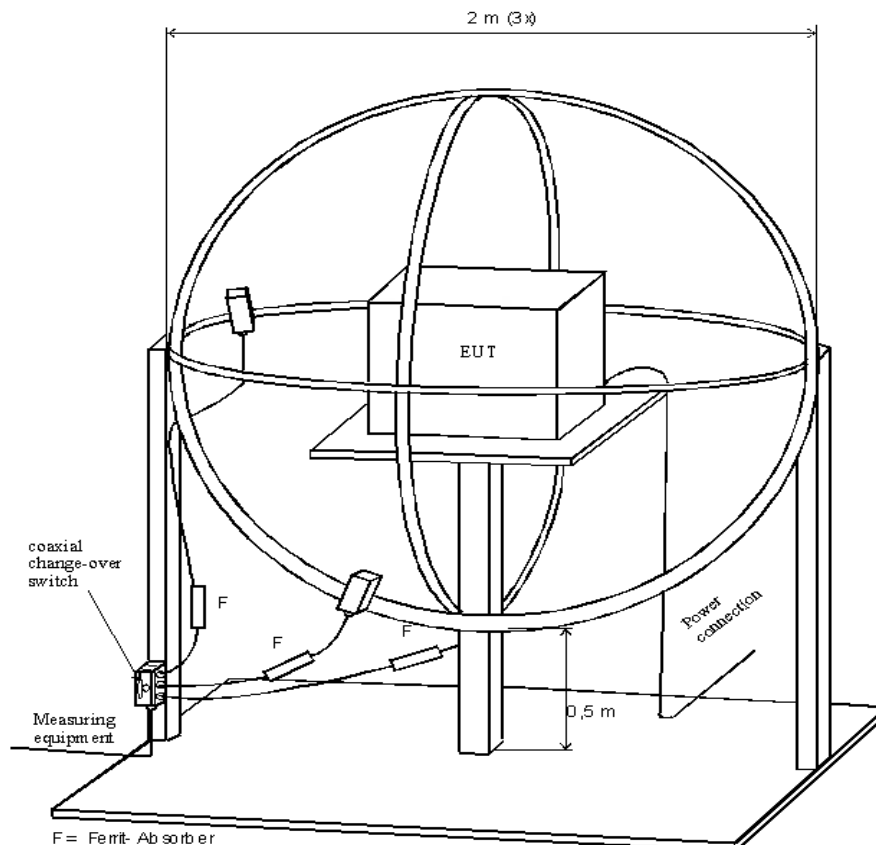

The EUT is placed in the centre of the loop antenna system. The current induced by the magnetic field from the EUT into each of the three large loop antennas of the loop antenna system is measured by connecting the current probe of the large loop antenna to a measuring receiver. During the measurements the EUT remains in a fixed position. Before get the final emission results with quasi-peak(QP) detector, a pre-scan was performed with the peak(PK) to find out the maximum emission data plots of the EUT.

4.2.3 Results

Level

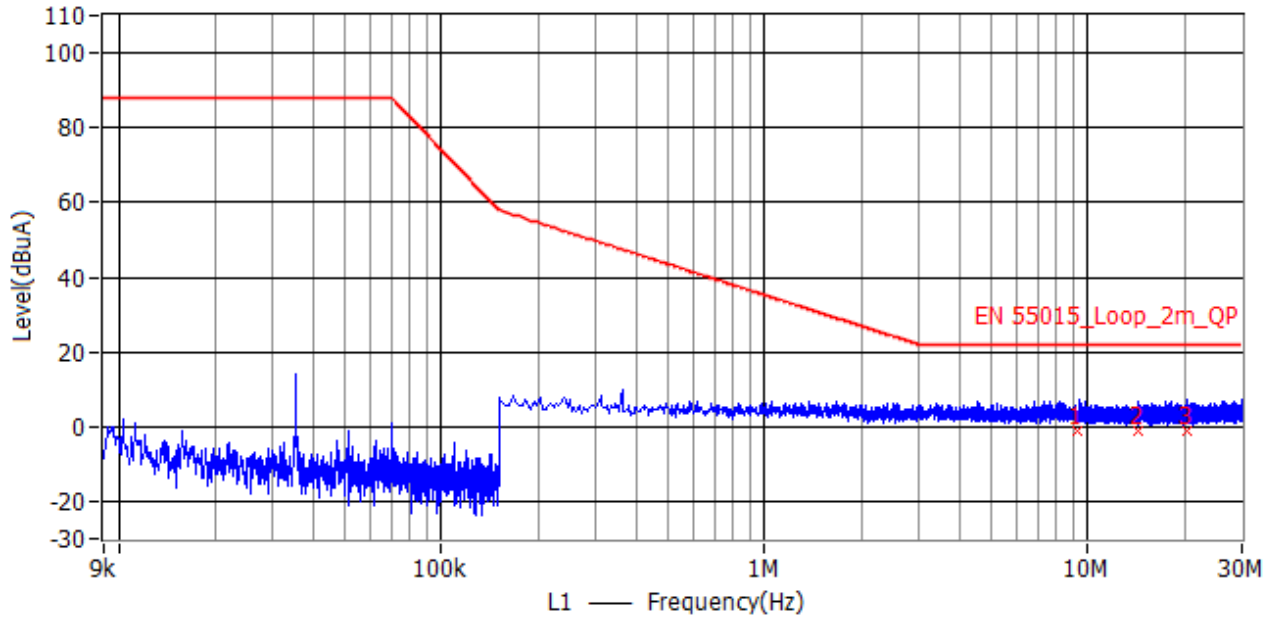

No.	Frequency	Limit dBuA	Level dBuA	Delta Limit dB	Detector	Polar
1	9.286 MHz	22.0	-1.0	-23.0	QP	X
2	14.350 MHz	22.0	-1.2	-23.2	QP	X
3	20.246 MHz	22.0	-1.0	-23.0	QP	X

Level

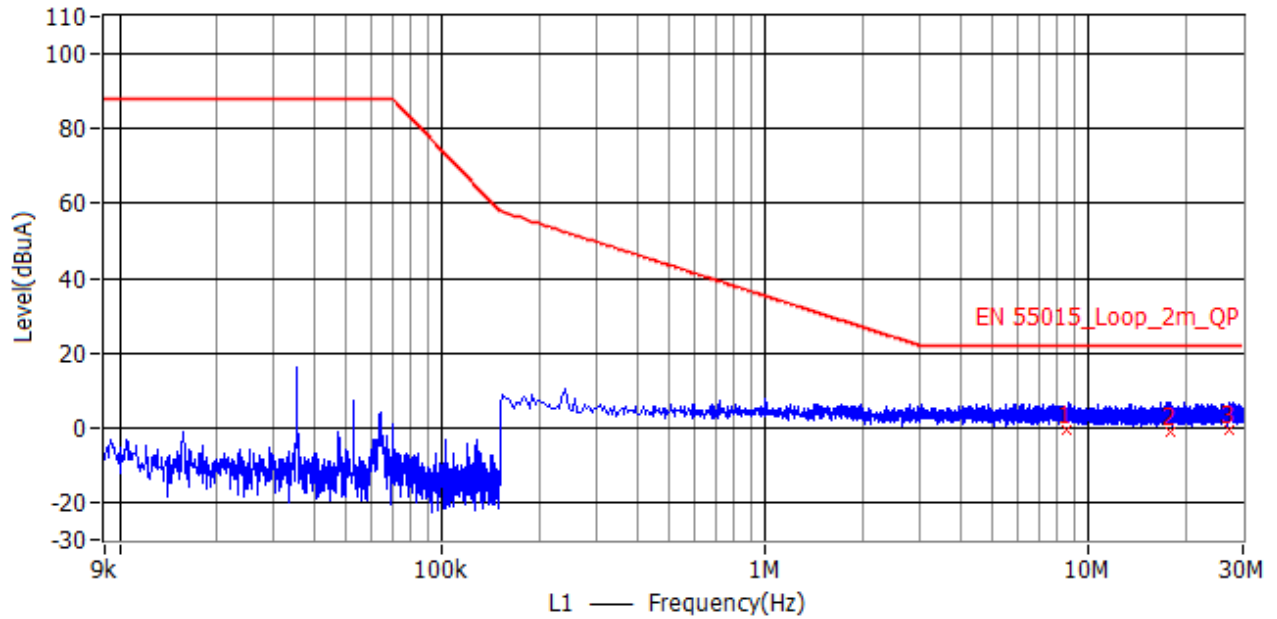

No.	Frequency	Limit dBuA	Level dBuA	Delta Limit dB	Detector	Polar
1	8.590 MHz	22.0	-0.8	-22.8	QP	Y
2	17.866 MHz	22.0	-1.2	-23.2	QP	Y
3	27.138 MHz	22.0	-0.7	-22.7	QP	Y

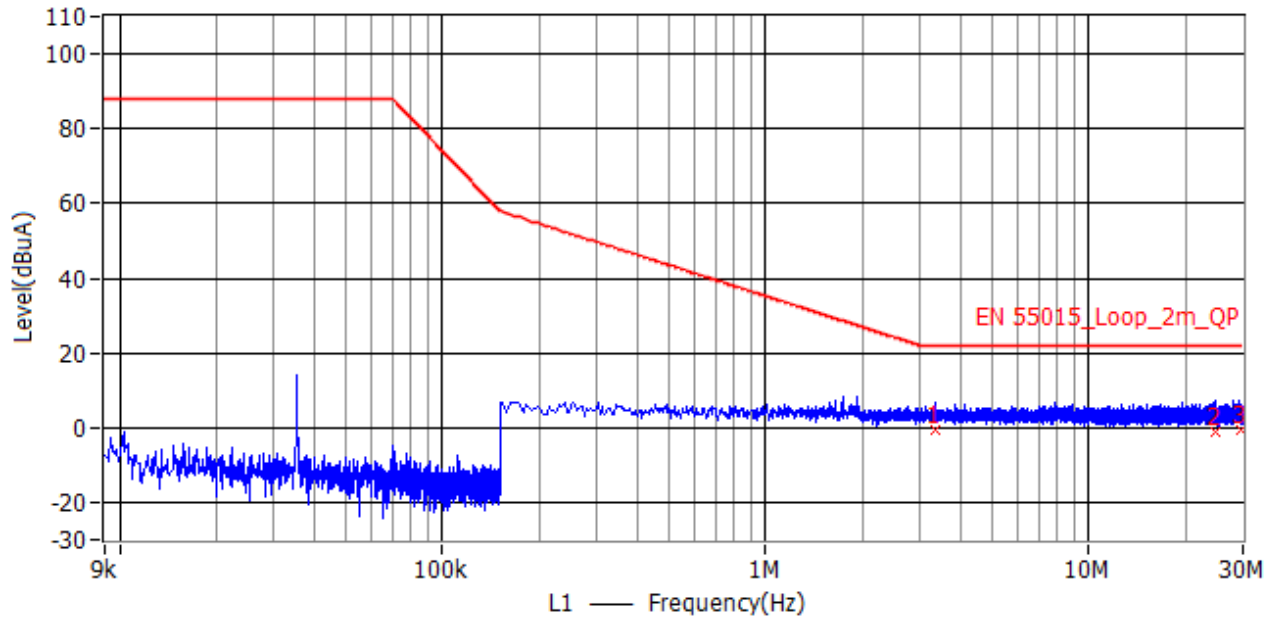
Level

No.	Frequency	Limit dBuA	Level dBuA	Delta Limit dB	Detector	Polar
1	3.334 MHz	22.0	-0.8	-22.8	QP	Z
2	24.646 MHz	22.0	-0.9	-22.9	QP	Z
3	29.454 MHz	22.0	-0.7	-22.7	QP	Z

4.3 Radiated disturbance

This clause lays down the general requirements for the measurement of Radiated disturbance produced at the space of apparatus.

4.3.1 Limits

Frequency range	Quasi-peak limits at 3m
MHz	dB ($\mu\text{V/m}$)
30 to 230	40
230 to 300	47

At transitional frequencies the lower limit applies.

4.3.2 Measurement procedure

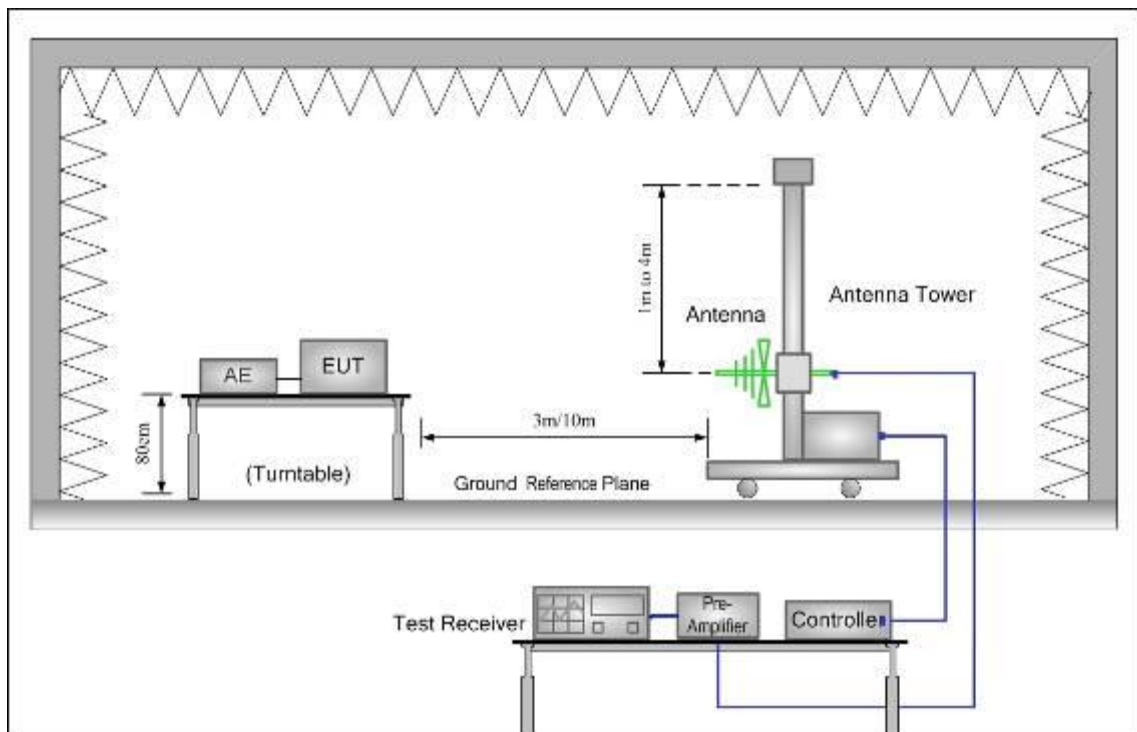

1. The radiated emissions test was conducted in a semi-anechoic chamber. The EUT was placed upon a non-metallic table 0.8m above the ground reference plane. And for floor-standing arrangement, the EUT was placed on the horizontal ground reference plane, but separated from metallic contact with the ground reference plane by 0.1m of insulation.
2. Before get the final emission results with quasi-peak(QP) detector, a pre-scan was performed with the peak(PK) detector to find out the maximum emission data plots of the EUT.
3. The frequencies of maximum emission were determined in the final radiated emissions measurement, the physical arrangement of the test system and associated cabling was varied in order to determine the effect on the EUT's emissions in amplitude, direction and frequency. At each frequency, the EUT was rotated 360°, and the antenna was raised and lowered from 1 to 4 meters in order to determine the maximum disturbance. Measurements were performed for both horizontal and vertical antenna polarization. Test was performed on subcontractor at 3 m distance.

4.3.3 Measurement uncertainty

The maximum measurement uncertainty is evaluated as:
 Horizontal: 30MHz~1GHz: 4.56dB
 Vertical: 30MHz~1GHz: 4.55 dB

4.3.4 Results

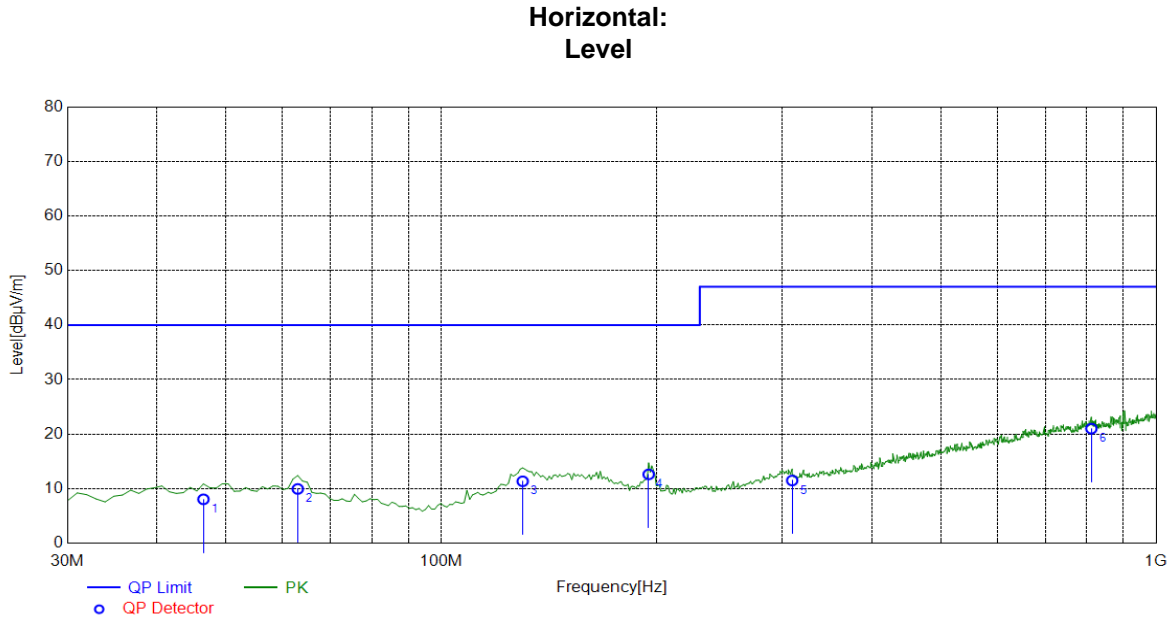

Final Data List								
NO.	Freq. [MHz]	Factor [dB/m]	QP Value [dBµV/m]	QP Limit [dBµV/m]	QP Margin [dB]	Height [cm]	Angle [°]	Polarity
1	46.5065	-16.22	8.05	40.00	31.95	100	360	Horizontal
2	63.0130	-17.24	9.95	40.00	30.05	200	343	Horizontal
3	130.0100	-16.72	11.35	40.00	28.65	200	185	Horizontal
4	195.0651	-17.89	12.62	40.00	27.38	100	317	Horizontal
5	309.6396	-15.22	11.50	47.00	35.50	100	33	Horizontal
6	811.6316	-6.65	21.01	47.00	25.99	200	291	Horizontal

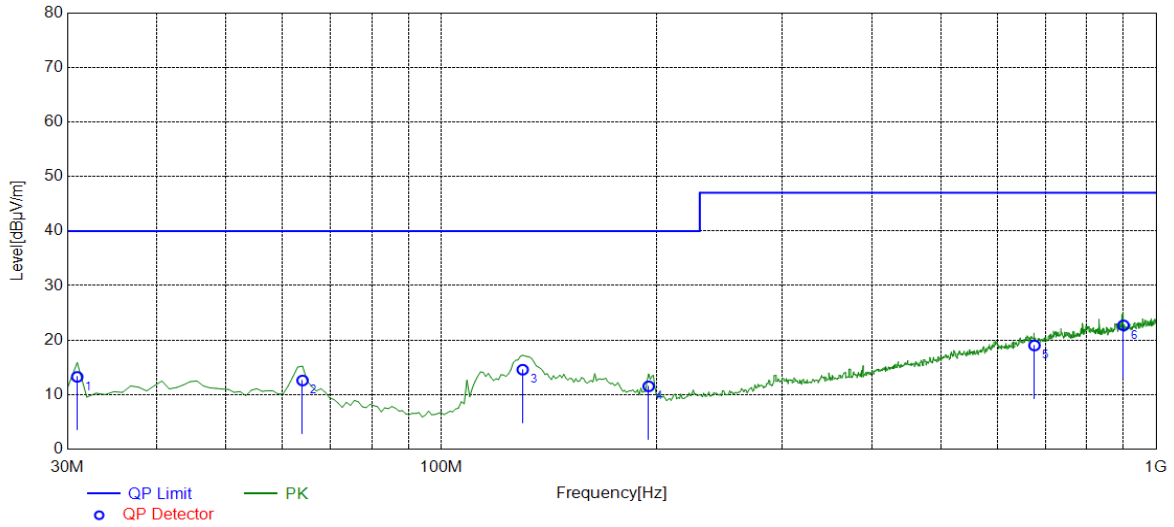
**Vertical:
Level**

Final Data List								
NO.	Freq. [MHz]	Factor [dB/m]	QP Value [dBµV/m]	QP Limit [dBµV/m]	QP Margin [dB]	Height [cm]	Angle [°]	Polarity
1	30.9710	-18.14	13.26	40.00	26.74	100	16	Vertical
2	63.9840	-17.49	12.60	40.00	27.40	100	72	Vertical
3	130.0100	-16.72	14.58	40.00	25.42	100	16	Vertical
4	195.0651	-17.89	11.53	40.00	28.47	100	210	Vertical
5	675.6957	-8.42	19.02	47.00	27.98	200	191	Vertical
6	899.9900	-5.84	22.71	47.00	24.29	200	329	Vertical

4.4 Voltage Changes, Voltage Fluctuations and Flicker

This part is concerned with the limitation of voltage fluctuations and flicker impressed on the public low-voltage system.

4.4.1 Limits

Value	Limit
Pst	1,0
Plt	0,65
dt	3,3%
dc	3,3%
dmax	4,0%

Note: Pst and Plt evaluations are required only for lighting equipment which is likely to produce flicker; for example: disco lighting and automatically regulated equipment.

4.4.2 Measurement test procedure

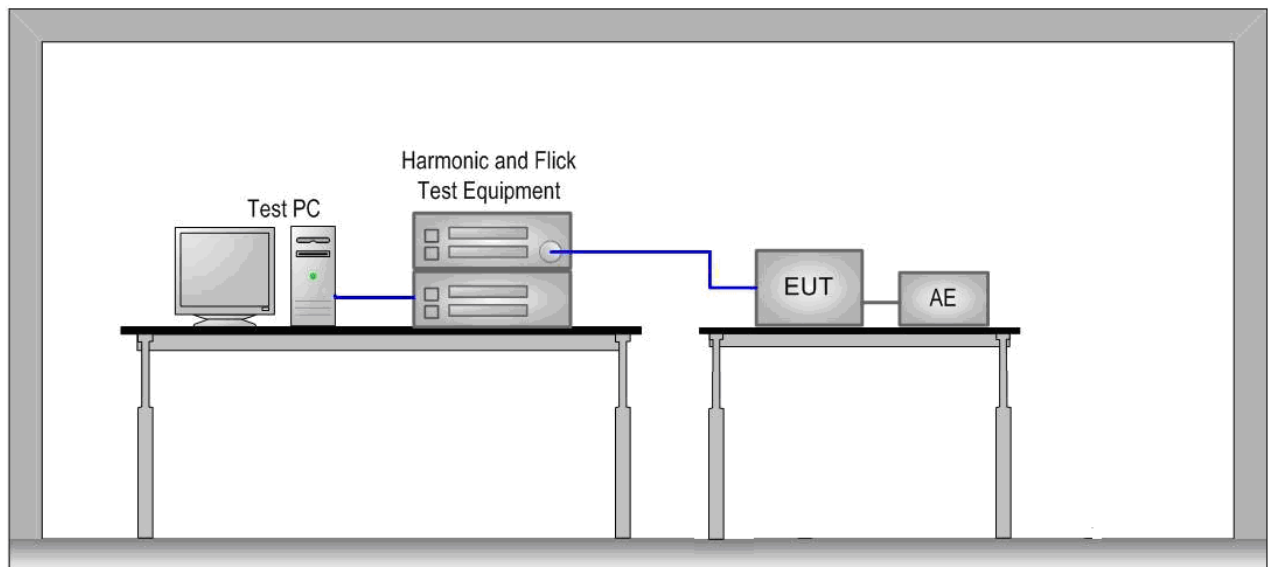

The equipment under test is placed on a wooden table with a height of 0,8 m in the EMC lab. The voltage changes, fluctuations and flicker were measured at the supply terminals of the EUT.

4.4.3 Results

Parameter values recorded during the test:

Vrms at the end of test (Volt):	229.86		
T-max (mS):	0	Test limit (mS):	500.0 Pass
Highest dc (%):	0.00	Test limit (%):	3.30 Pass
Highest dmax (%):	0.00	Test limit (%):	4.00 Pass

5 Immunity Test

5.1 Performance Criteria Description in Clause 4 of EN 61547

Criterion A:	During the test, no change of the luminous intensity shall be observed and the regulating control, if any, shall operate during the test as intended.
Criterion B:	During the test, the luminous intensity may change to any value. After the test, the luminous intensity shall be restored to its initial value within 1 min. Regulating controls need not function during the test, but after the test, the mode of the control shall be the same as before the test provided that during the test no mode changing commands were given.
Criterion C:	During and after the test, any change of the luminous intensity is allowed and the lamp(s) may be extinguished. After the test, within 30 min, all functions shall return to normal, if necessary by temporary interruption of the mains supply and/or operating the regulating control. Additional requirement for lighting equipment incorporating a starting device: After the test, the lighting equipment is switched off. After half an hour, it is switched on again. The lighting equipment shall start and operate as intended.

5.2 Conditions during testing

The test shall be applied while the equipment is operated as intended under the normal operating conditions as laid down in the relevant product standard at stabilized luminous (radiant) flux and at normal laboratory conditions. Testing is only required at one combination of supply voltage and frequency, as specified by the manufacturer. Equipment including a regulating control shall be tested at a light output level of $50\% \pm 10\%$. The lamp load of the equipment under test shall be the maximum allowed. Luminaires and independent auxiliaries shall be tested with lamps for which they are intended. Where equipment can operate with lamps of different wattages, lamps of maximum wattage shall be applied. For independent auxiliaries, the length of the cables between device and lamp shall be 3 m unless the manufacturer prescribes another length.

5.3 Electrostatic discharge

5.3.1 Test Procedures

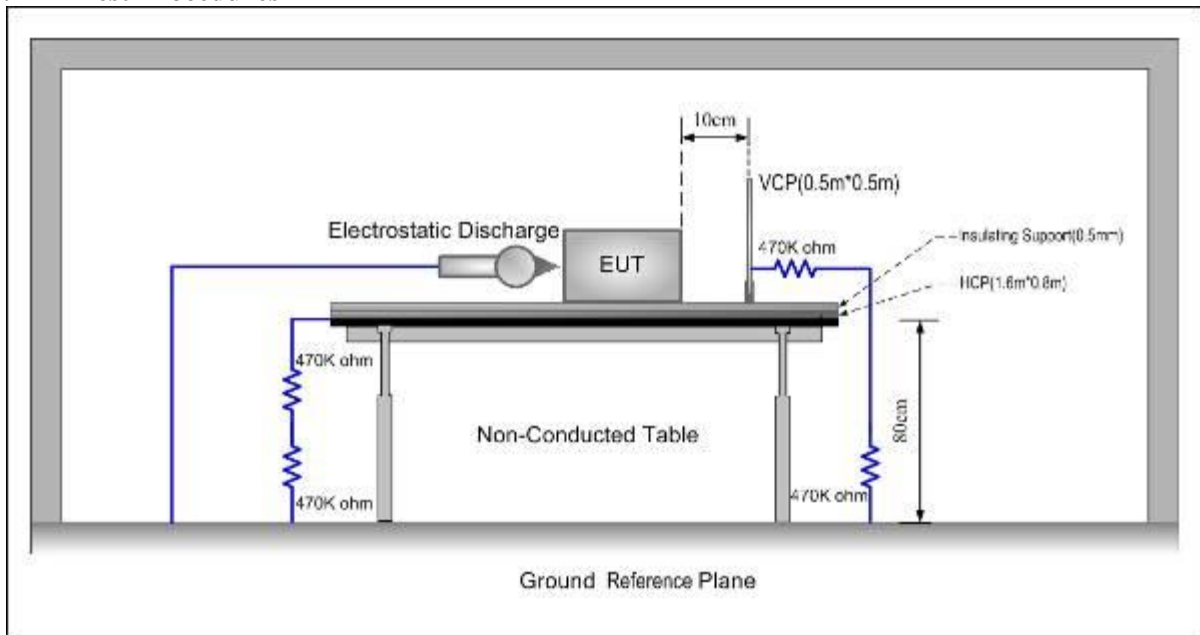

1. Contact discharge was applied only to conductive surfaces of the EUT. Air discharge was applied only to non-conducted surfaces of the EUT.
2. The EUT was put on a 0.8m high wooden table for table-top equipment or 0.1m high for floor standing equipment standing on the ground reference plane (GRP).
3. A horizontal coupling plane(HCP) 1.6m by 0.8m in size was placed on the table, and the EUT with its cables were isolated from the HCP by an insulating support thick than 0.5mm. The VCP 0.5m by 0.5m in size while HCP were constructed from the same material type and thickness as that of the GRP, and connected to the GRP via a 470kΩ resistor at each end. The distance between EUT and any of the other metallic surfaces excepted the GRP, HCP and VCP was greater than 1m.
4. During the contact discharges, the tip of the discharge electrode was touching the EUT before the discharge switch is operated. During the air discharges, the round discharge tip of the discharge electrode was approached as fast as possible to touch the EUT. After each discharge, the ESD generator was removed from the EUT, the generator is then retriggered for a new single discharge. For ungrounded product, a discharge cable with two resistances was used after each discharge to remove remnant electrostatic voltage. 10 times of each polarity single discharge were applied to HCP and VCP.

5.3.2 Results

Test point	Table (T) Floor (F)	Contact (C) Air (A)	Voltage (kV)	Number of discharge	Polarity (+ / -)	Opinion
Air discharge	T	A	8	20	+ / -	N/A
Contact discharge	T	C	4	20	+ / -	A
HCP	T	C	4	20	+ / -	A
VCP	T	C	4	20	+ / -	A

A: no loss of function.

5.4 Radio frequency electromagnetic fields

5.4.1 Measurement procedure

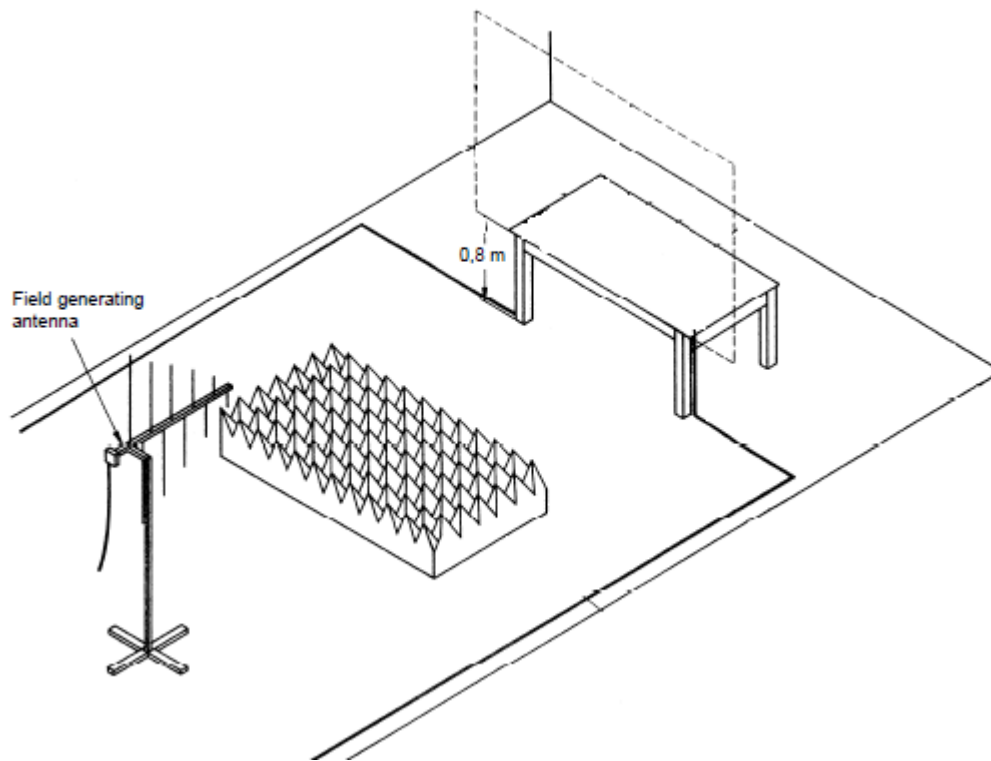

1. The EUT was placed on 0.8m high wooden table for table-top equipment. For floor standing equipment, the EUT was placed on a 0.1m high wooden support above the GRP. The tests normally shall be performed with the generating antenna facing each of four sides of the EUT. When equipment can be used in different orientations (e.g. vertical or horizontal) the test shall be performed on all possible sides of the EUT.
2. The tests are carried out with a field strength by 3 V/m (measured in the unmodulated field) with amplitude modulated signal by a depth of 80 % by a sinusoidal audio signal of 1 kHz. The logarithmic step was 1% and the dwell time was 3s dependent of the EUT cycle time. Test was performed on subcontractor.

5.4.2 Results

Frequency Range	Field Strength	Modulation	Opinion
80MHz to 1GHz	3V/m	80% AM 1kHz	A

A: no loss of function.

5.5 Electrical Fast Transients

5.5.1 Measurement procedure

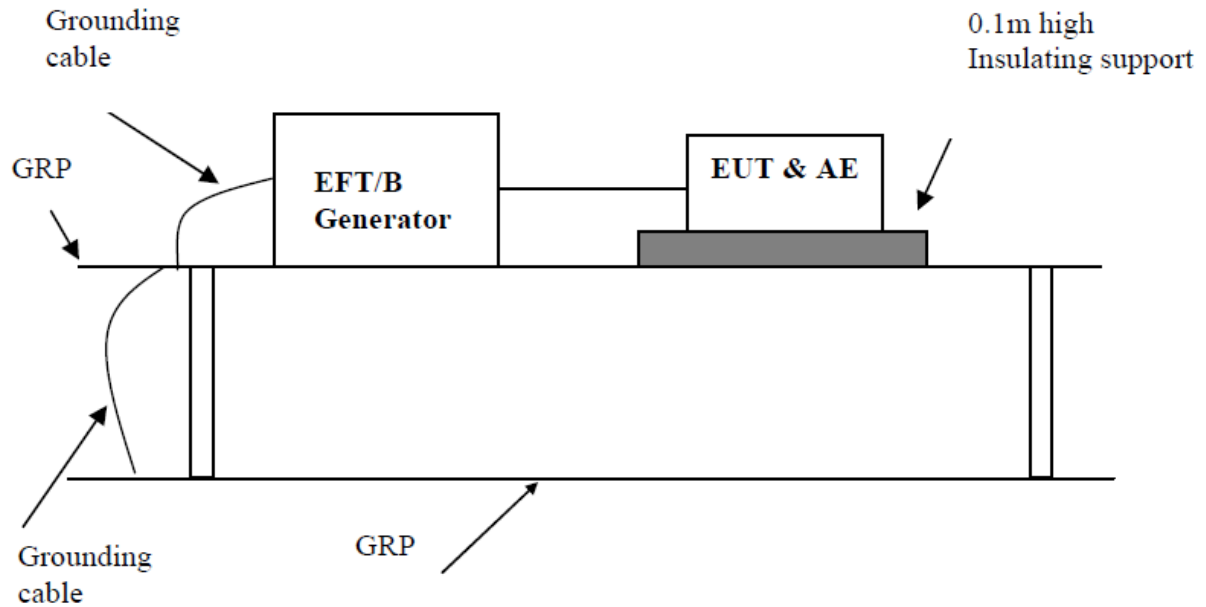

1. The EUT was placed on a ground reference plane (GRP) insulated by an insulating support 0,1 m thick and the GRP was placed on a 0.8m high wooden table for table-top equipment. For floor standing equipment, the EUT was placed on a 0.1m high wooden support above the GRP.
2. The GRP shall project beyond the EUT and the clamp by at least 0.1m on all sides. The distance between the EUT and any other of the metallic surface except the GRP was greater than 0.5m. All cables to the EUT were placed on the insulation support 0.1m above GRP. Cables not subject to EFT were routed as far as possible from cable under test to minimize the coupling between the cables.
3. The length of signal and power cable between the EUT and EFT generator was 0.5m. If the cable is a non-detachable supply cable more than 0.5m, the excess length of this cable shall be folded to avoid a flat coil and situated at a distance of 0.1m above the GRP.

5.5.2 Results

Test port	Voltage (kV)	Polarity (+ / -)	Duration (s or min)	Waveform Tr / Th	Repetition Frequency (kHz)	Opinion
AC power port	1	+ / -	2 min	5/50 ns	5	A

A: no loss of function.

5.6 Surge Immunity

5.6.1 Measurement procedure

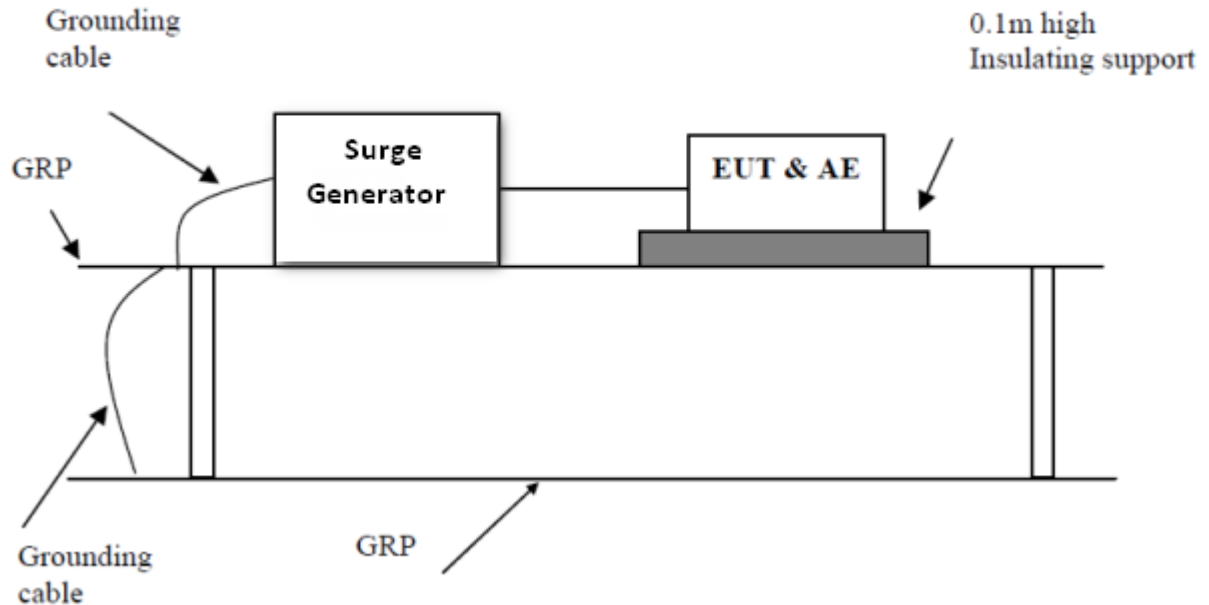

1. The EUT was placed on a ground reference plane (GRP) insulated by an insulating support 0.1 m thick and the GRP was placed on a 0.8m high wooden table for table-top equipment. For floor standing equipment, the EUT was placed on a 0.1m high wooden support above the GRP.
2. The 1.2/50 μ s surge was to be applied to the EUT power supply terminals via the capacitive coupling network. Decoupling networks were required in order to avoid possible adverse effects on equipment not under test that may be powered by the same lines and to provide sufficient decoupling impedance to the surge wave so that the specified wave may be applied on the lines under test.
3. Pulses shall be applied to the a.c. voltage wave as follows; five positive polarity pulses at the 90° phase angle, five negative polarity pulses at the 270° phase angle.

5.6.2 Results

Test mode	Voltage (kV)	Waveform Tr / Th	Number of pulses	Opinion
Line to line	0.5	1.2/50 μ s	5 (+/-)	A
Line to earth	1	1.2/50 μ s	5 (+/-)	A

A: no loss of function.

5.7 Injected currents (RF continues conducted)

5.7.1 Measurement procedure

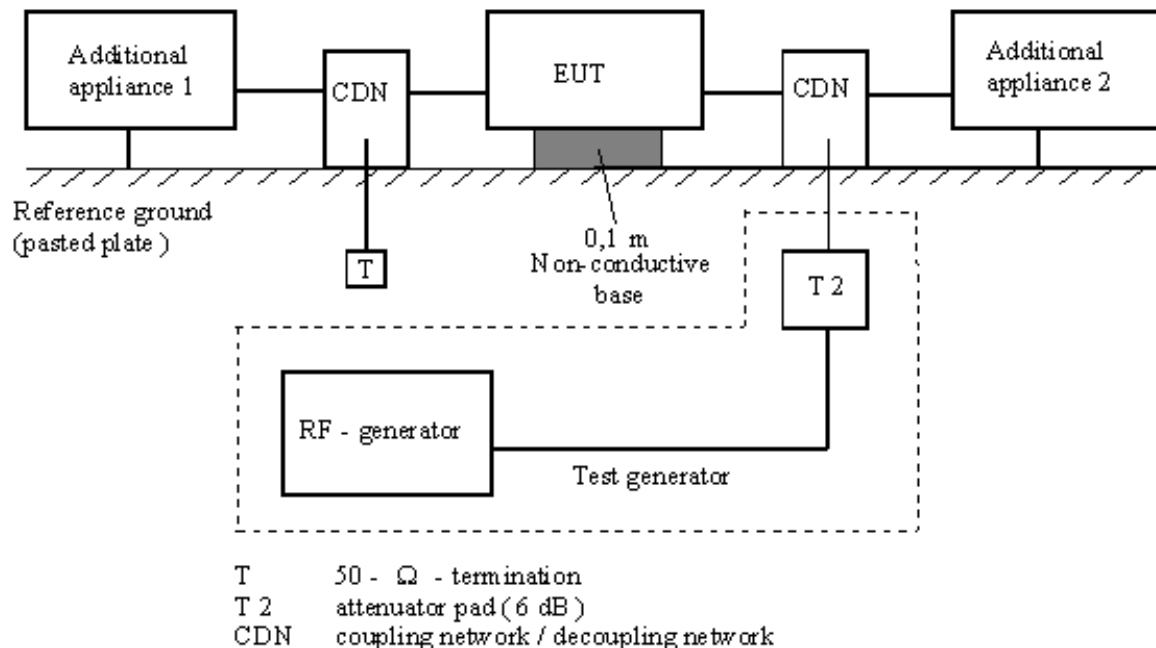

1. The EUT was placed on an insulating support of 0.1m height above a ground reference Plane, arranged and connected to satisfy its functional requirement. All cables exiting the EUT was supported at a height of at least 30 mm above the ground reference plane.
2. The coupling and decoupling devices were required, they were located between 0,1 m and 0,3 m from the EUT. This distance was to be measured horizontally from the projection of the EUT on to the ground reference plane to the coupling and decoupling device.
3. The frequency range was swept from 150 kHz to 80 MHz, using the signal levels established during the setting process, and with the disturbance signal 80 % amplitude modulated with a 1 kHz sine wave, pausing to adjust the RF signal level or to change coupling devices as necessary. Where the frequency was swept incrementally, the step size does not exceed 1 % of the preceding frequency value. The dwell time of the amplitude modulated carrier at each frequency was not less than the time necessary for the EUT to be exercised and to respond, and was not less than 3 s.

5.7.2 Results

Test port	Voltage (e.m.f.)	Modulation	Frequency Range	Opinion
AC power port	3V	80% AM 1 kHz	150 kHz to 80 MHz	A

A: no loss of function.

5.8 Power-frequency magnetic fields

The magnetic fields to which equipment is subjected may influence the reliable operation of equipment and systems.

5.8.1 Measurement procedure

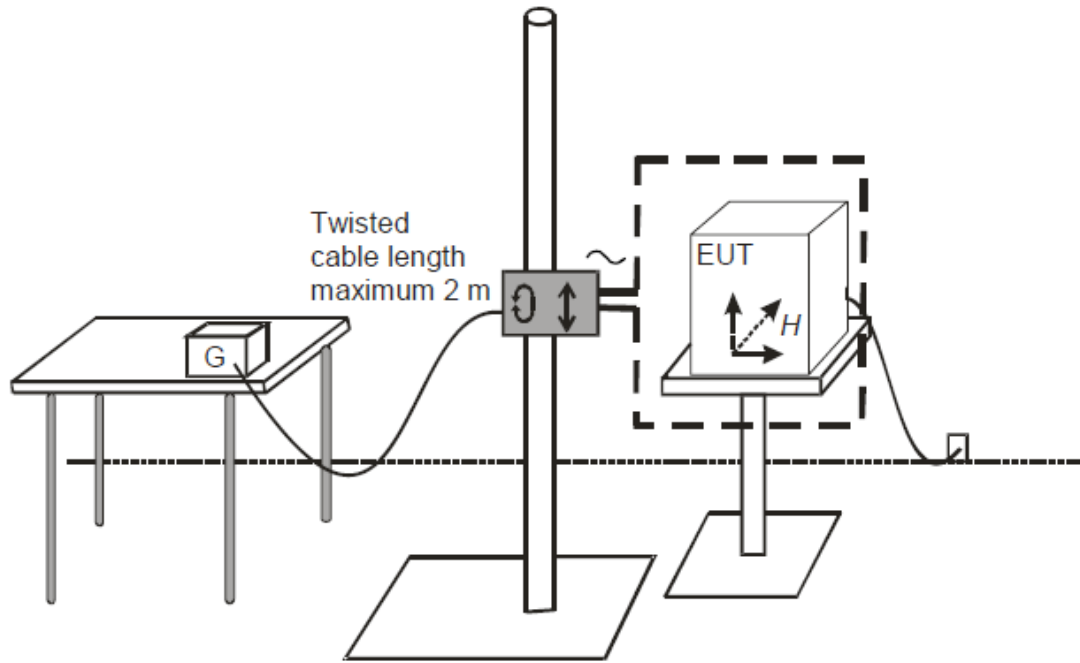

The electromagnetic conditions of the laboratory shall be such as to guarantee the correct operation of the EUT in order not to influence the test results; otherwise, the tests shall be carried out in a Faraday cage. The plane of the inductive coil shall then be rotated by 90° in order to expose the EUT to the test field with different orientations.

5.8.2 Results

Test Frequency	Field Level (A/m)	Duration (Second)	Axis of Orientation	Opinion
50/60Hz	3	60	X	A
50/60Hz	3	60	Y	A
50/60Hz	3	60	Z	A

A: no loss of function.

5.9 Voltage dips and Interruption

5.9.1 Measurement procedure

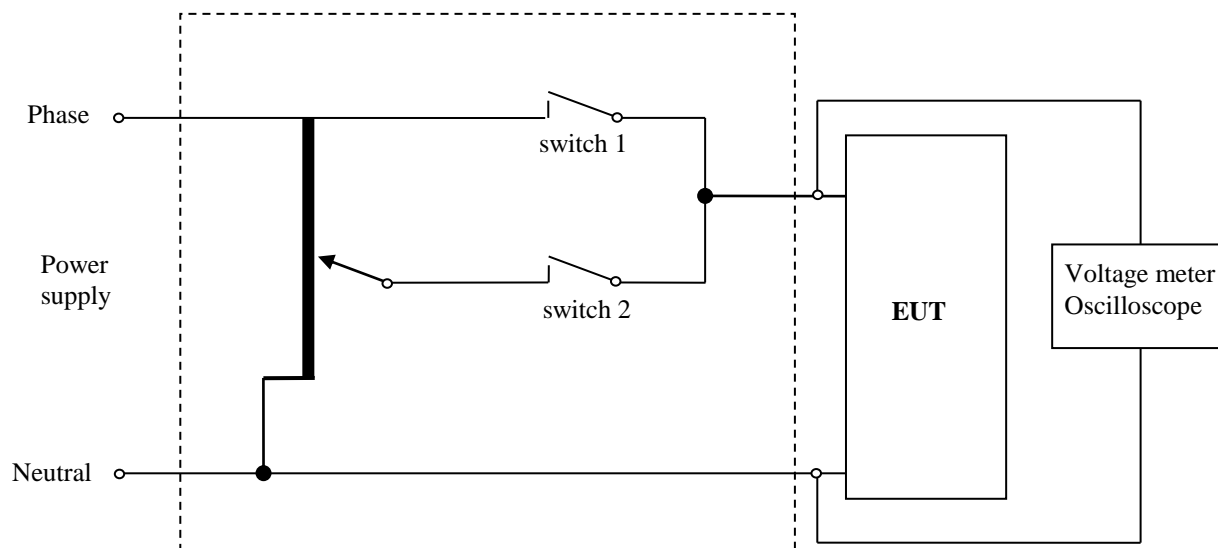

1. The EUT was placed on a ground reference plane (GRP) insulated by an insulating support 0,1 m thick and the GRP was placed on a 0.8m high wooden table for table-top equipment. For floor standing equipment, the EUT was placed on a 0.1m high wooden support above the GRP.
2. The test was performed with the EUT connected to the test generator with the shortest power supply cable as specified by the EUT manufacturer. Changes to the voltage level shall occur at a zero crossing point in the a.c. voltage waveform.
3. The EUT was tested for each selected combination of test level and duration with a sequence of three dips /interruptions with intervals of 10 s minimum. Each representative mode of operation was tested.

5.9.2 Results

Reduction of supply voltage	Voltage in % (in V)	Duration in parts of period (in ms)	Opinion
interruption	0 % (0V)	0,5 (10 ms)	A
30 %	70 % (161 V)	10 (200 ms)	A

A: no loss of function.

6 Test setup Photos

Conducted Emission

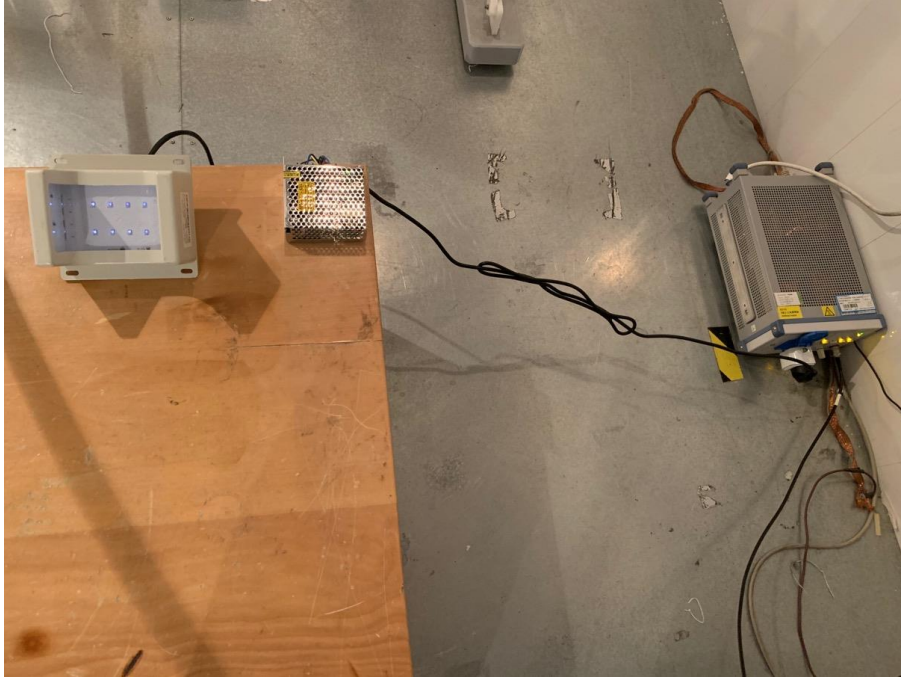

Radiated electromagnetic disturbances

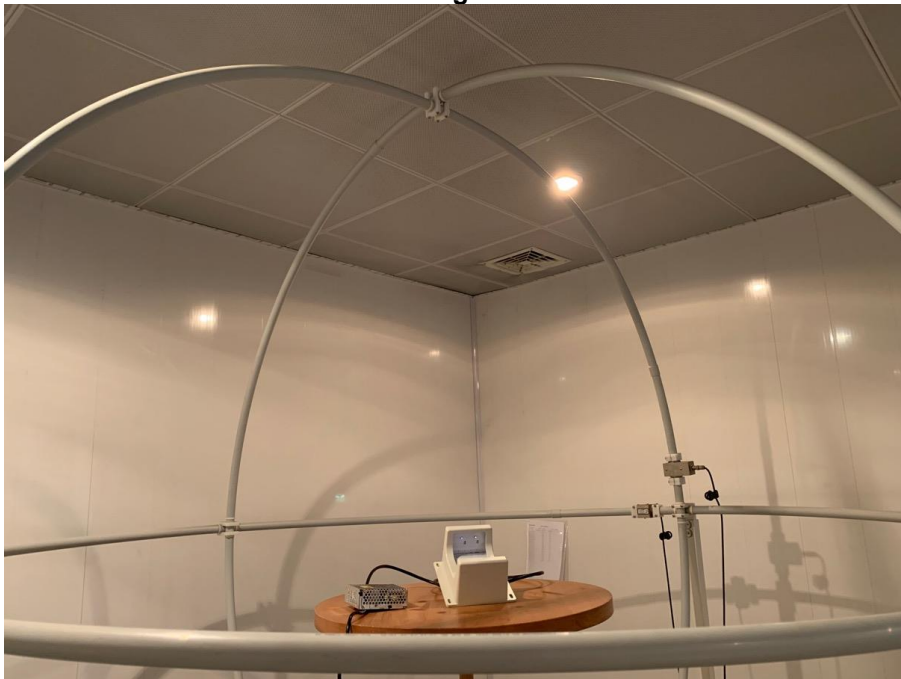

Radiated disturbance

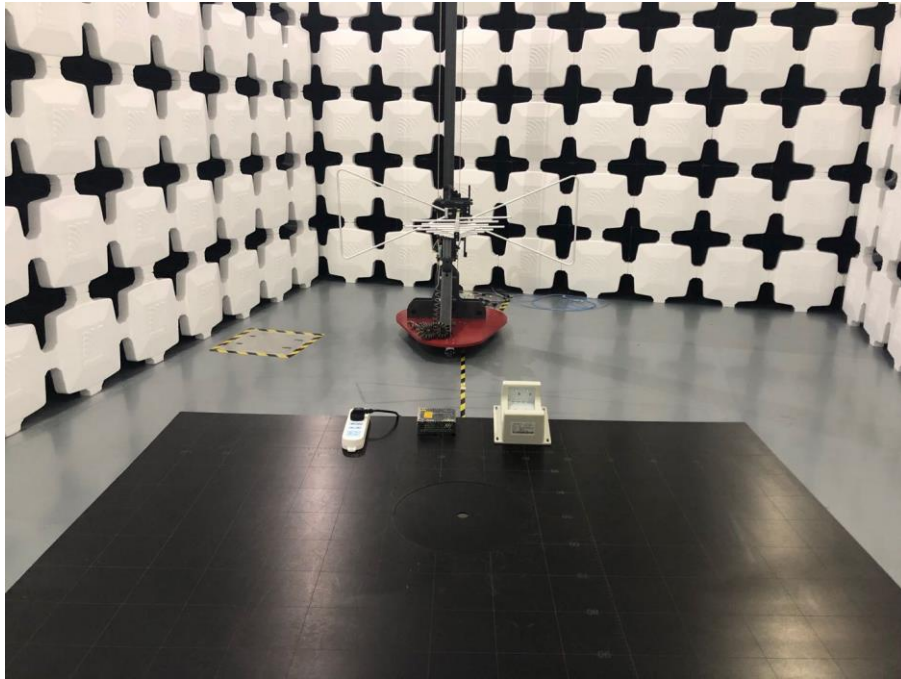

Harmonic Current Emissions/ Voltage Changes, Voltage Fluctuations and Flicker



Electrostatic Discharge



Radio frequency electromagnetic fields



Electrical Fast Transients/ Surge immunity/ Voltage dips and short interruption**Injected currents (RF common mode)**

Power-frequency magnetic field

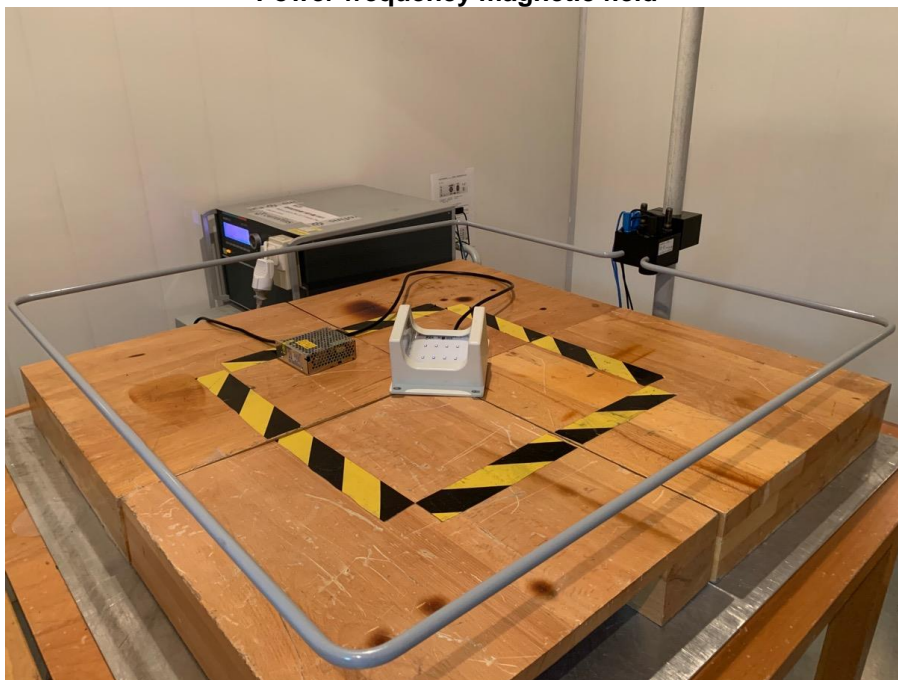

7 EUT Photos

Photo 1
Overall view for product



Photo 2
Power supply view

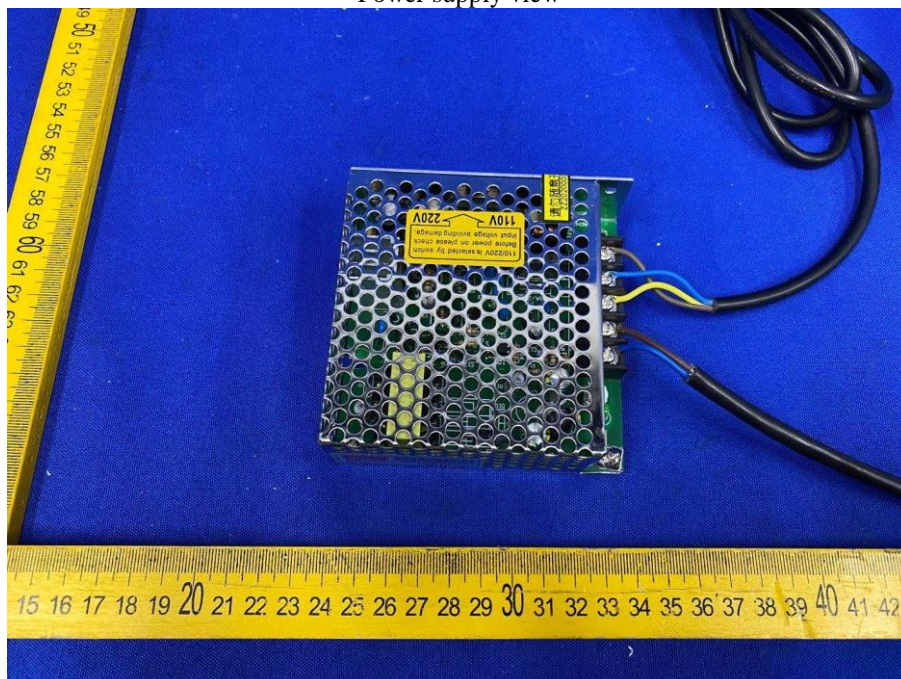

Photo 3
Label view



Photo 4
Internal view

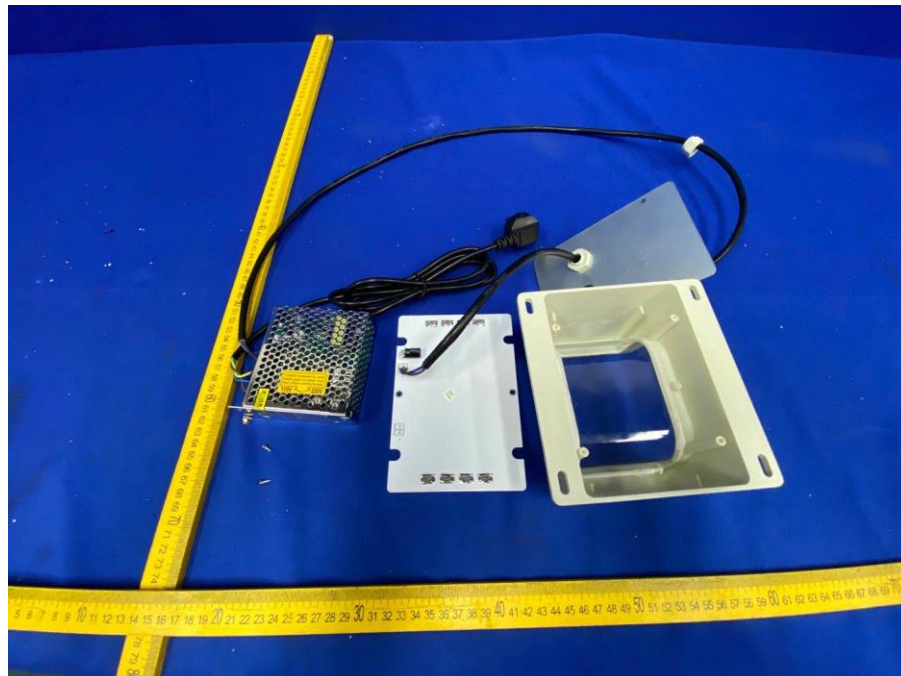

Photo 5
LED view

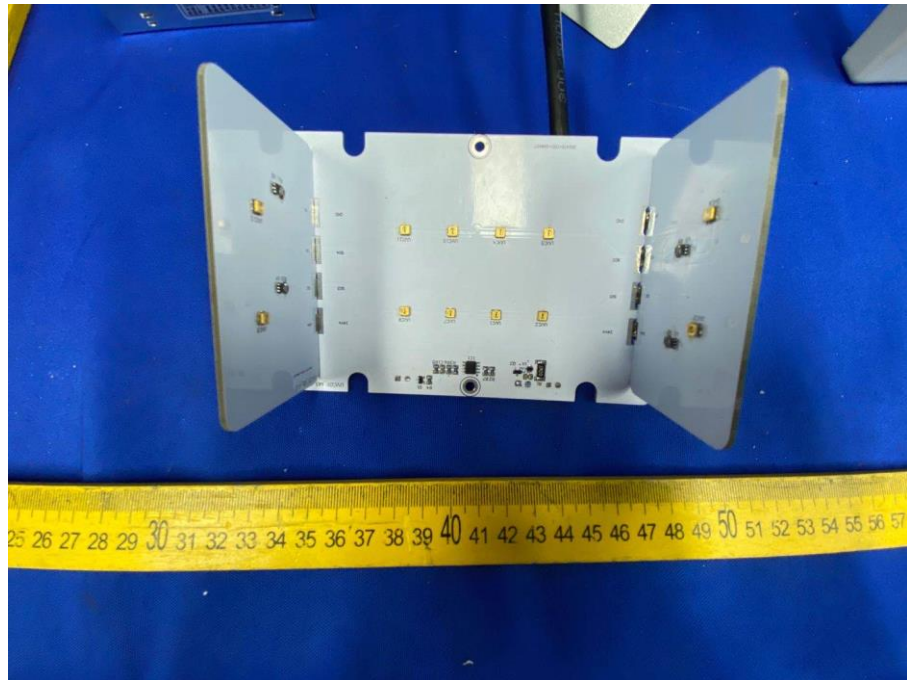

Photo 6
LED view

